

Engrenages coniques, KKM103030

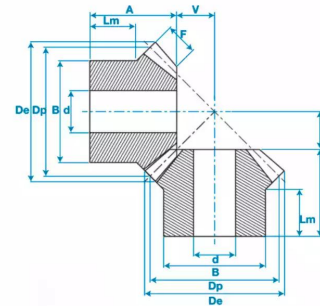

Engrenages coniques

Type 1



Description

Engrenages coniques, référence KKM103030. Engrenage module 1 avec 30/30 dents.

Détails du produit

Détails du produit

Dp (mm)	30
De (mm)	31.4
Diam int. (mm)	5
Largeur dents (mm)	6.4